

Plastic - Pin - Wired

NCP-WD

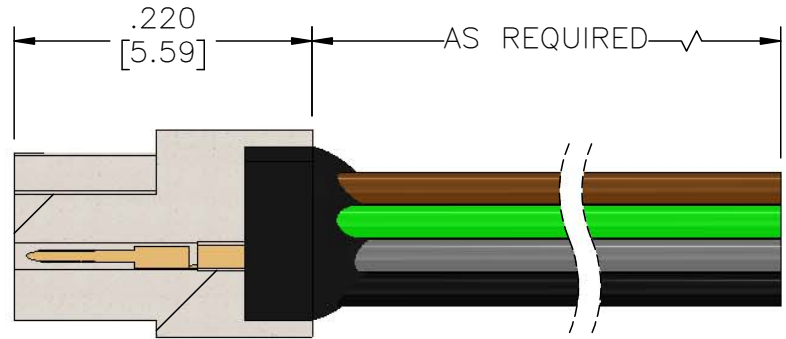
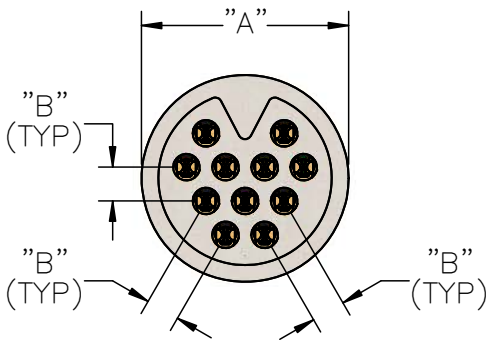
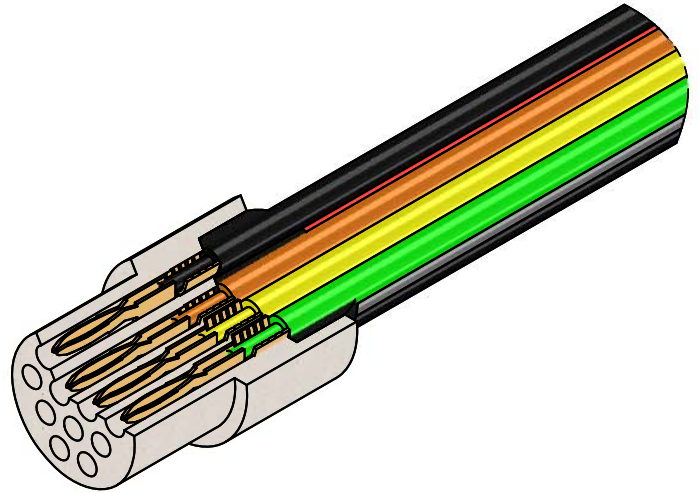
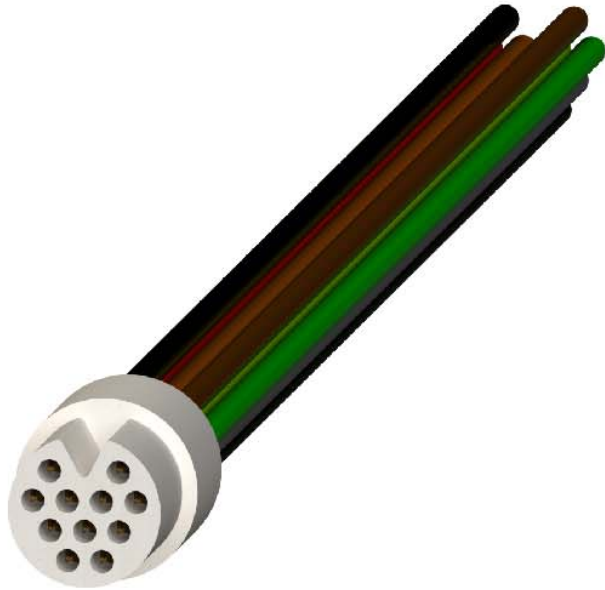

Part #	Contacts	English (IN)		Metric (MM)	
		A	B	A	B
A79100-001	6	0.122	0.025	3.10	0.64
A79102-001	11	0.153		3.89	
A79104-001	15	0.181		4.60	
A79106-001	28	0.217		5.51	
A79120-001	39	0.305	0.035	7.75	0.89

Plastic - Socket - Wired NCS-WD

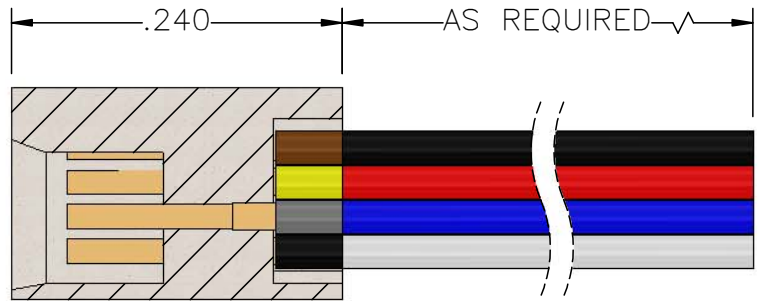
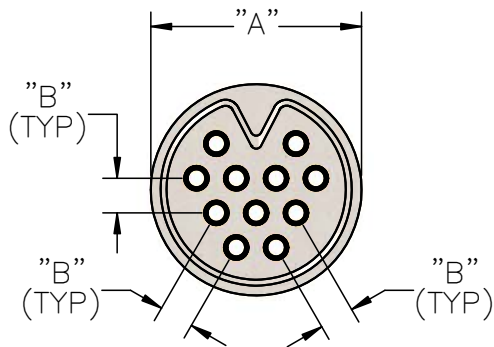
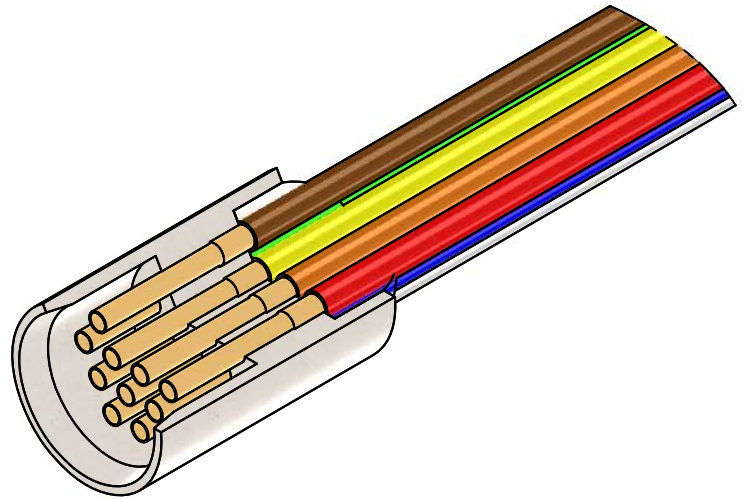

Part #	Contacts	English (IN)		Metric (MM)	
		A	B	A	B
A79101-001	6	0.122	0.025	3.10	0.64
A79103-001	11	0.153		3.89	
A79105-001	15	0.181		4.60	
A79107-001	28	0.217		5.51	
A79121-001	39	0.305	0.035	7.75	0.89